

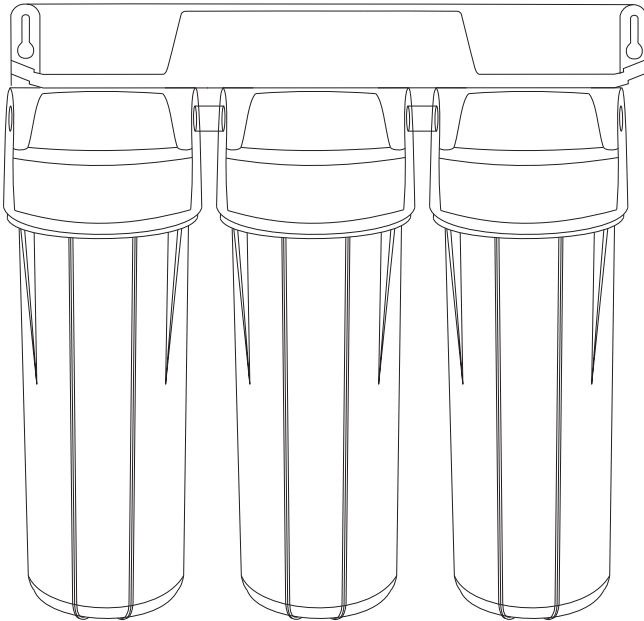

**The Clear Choice**  
Water Filtration Systems



## 1. Safety Precautions

**WARNING!!! The system should not be used with biologically contaminated water or water of unknown origin.**

**Product may be installed only by trained service professionals. Only original replacement parts, filter cartridges and accessories made by manufacturer may be used.**

Compliance with the following instructions ensures:

- problem free product operation,
- manufacturer's warranty.

Failure to comply with the following instructions will result in loss of warranty.

- 1) Read carefully this Instruction Manual before beginning system installation.
- 2) Check if all elements needed for the installation are included with the system. (refer to point 4 "Included in the Box").
- 3) Please note that after installing the system, as well as after each filter cartridge and hollow fiber membrane replacements, and in the case of long inactivity of the system, system flushing procedure must be conducted before resuming system usage.
- 4) Before disconnecting any tubing: remove safety clips from quick connectors, and next press the connector's flange and pull the tubing out.
- 5) During disconnecting and connecting of tubing be sure not to break it (correctly installed tubing should be inserted 1.5 cm inside of quick connector).
- 6) Secure quick connector with safety clip after tubing has been inserted.
- 7) For sealing plastic components use only Teflon tape!
- 8) Do not use strong detergents when washing filter housings. Rinse filter housings with clean water each time before installing new filter cartridges.
- 9) Wash your hands thoroughly before and after filter cartridge or membrane element replacements.
- 10) In case system is leaking, disconnect it from its water supply.
- 11) In all cases of product returns, the system must be returned in its original packaging – otherwise the return will not be accepted.
- 12) Manufacturer is not responsible for any damages resulted from the use of this product if used for other purposes than filtration of potable water.
- 13) Manufacturer does not hold any responsibility for printing errors.
- 14) Manufacturer reserves the right to introduce change or amendments to the provided technical informations at any time and without the necessity of a prior announcement.

Use only genuine **Aqua Market®** and **Aquafilter®** replacement parts, filter cartridges and membrane elements. In case of use of other manufacturers' parts, Aquafilter is not responsible for any damages caused in the course of product use.

## 2. Technical Specifications

Inlet water temperature.....	between + 2°C (+ 35°F) and + 45°C (113°F)
Inlet water pressure.....	between 3,5 bar (52,5 psi)* and 6 bar (90 psi)
Water supply adapter.....	1/2"
Flexible tubing (outlet).....	1/4"
Membrane type.....	UF membrane

\* only in model: **FP3-HJ-K1, FP3-4, FP3-5.**

**IMPORTANT NOTE!** The system with UF membrane must be secured from high pressures and rapid pressure changes caused by local water supply systems. Pressure regulator must be installed on the inlet of the system's water supply. The system's optimal performance pressure is 3,5 bar (52,5 psi) - pressure regulator is set to this parameter by the manufacturer. Failure to install pressure regulator will result in loss of warranty for pressure-operated elements. Regulator may be purchased separately - catalog nr. **ADV-REG\_K, ADV-REG-CR\_K.**

### 3. Included in the Box

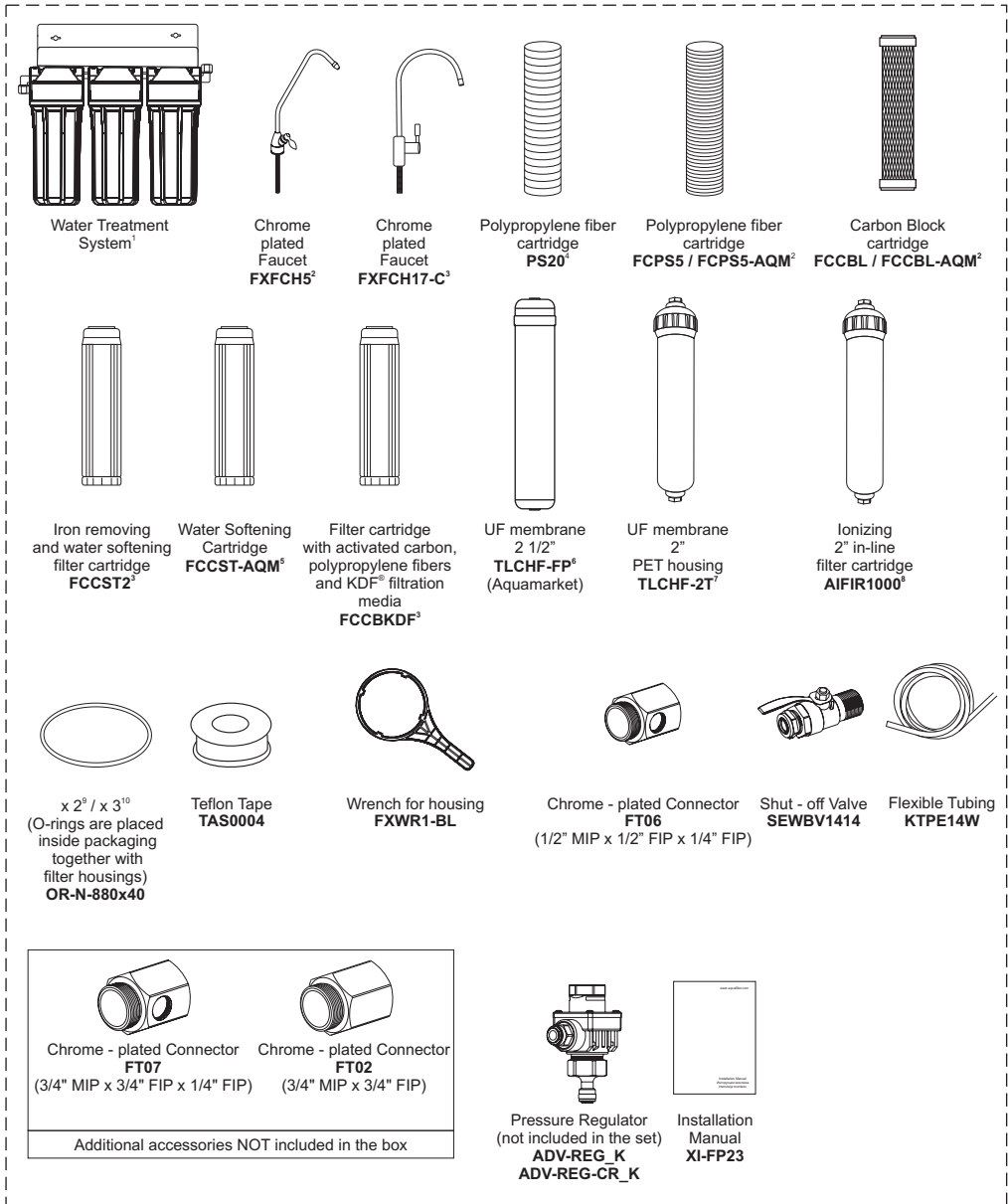

<sup>1</sup> depending on individual options it can be a system: FP2, FP3-2, FP3-K1, FP3-HJ-K1, FP3-3, FP3-4, FP3-5

<sup>2</sup> the element is a part of the system: FP2, FP3-2, FP3-3, FP3-4, FP3-5

<sup>3</sup> the element is a part of the system: FP3-K1, FP3-HJ-K1

<sup>4</sup> the element is a part of the system: FP3-2

<sup>5</sup> the element is a part of the system: FP3-3, FP3-4, FP3-5

<sup>6</sup> the element is a part of the system: FP3-4, FP3-5

<sup>7</sup> the element is a part of the system: FP3-HJ-K1

<sup>8</sup> the element is a part of the system: FP3-5

<sup>9</sup> the element is a part of the system: FP2

<sup>10</sup> the element is a part of the system: FP3-2, FP3-K1, FP3-HJ-K1, FP3-3, FP3-4, FP3-5

## 4. Connecting Flexible Tubing with Quick Connectors: JG (John Guest) and QC (Quick Connector)

### Disconnect Flexible Tubing:

- 1) Remove safety clip from the quick connector (if applicable) (Fig. 1).
- 2) Press on the flange of quick connector (Fig. 2).
- 3) Pull out flexible tubing (Fig. 3).

### Connect Flexible Tubing:

- 1) Push the flexible tubing 1.5 cm (0.6 in) deep into the quick connector (Fig. 4).
- 2) Insert safety clip (if applicable) (Fig. 5).

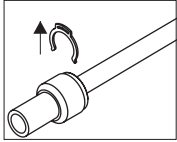

Fig. 1

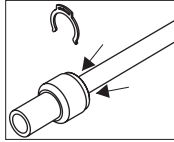

Fig. 2

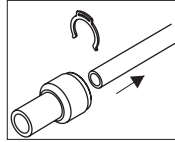

Fig. 3

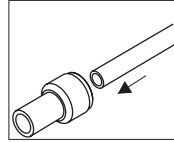

Fig. 4

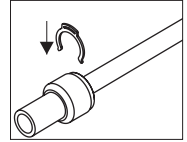

Fig. 5

## 4.1. Instructions for connecting and disconnecting filter cartridge and elbow connector (new filter cartridge with elbow connector)

### Disconnecting elbow connector from filter cartridge:

- 1) Remove safety clips from quick connector (fig.1).
- 2) Push quick connector's flange symmetrically and pull the tubing out (fig. 2).
- 3) Unscrew inlet and outlet connectors from old filter cartridge (fig.3)
- 4) Remove old Teflon tape (fig.4).
- 5) Apply multiply layers of new Teflon tape (ensure that Teflon tape is wound in the opposite direction to the direction connector will be installed) (fig. 5).

### Connecting elbow connector with filter cartridge:

- 1) Screw the elbow connector back to new filter cartridge.

**NOTE!** Do NOT remove elbow connector after the installation has been started. Stopping and removing (unscrewing) the element may result in inadequate connection and water leak. (fig.6).

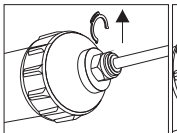

Fig. 1

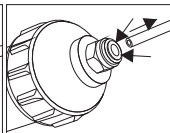

Fig. 2

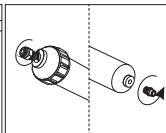

Fig. 3

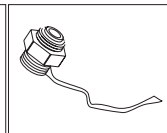

Fig. 4

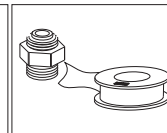

Fig. 5

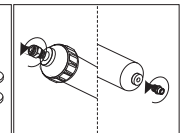

Fig. 6

## 4.2. Connecting Flexible Tubing with JACO-Type Connectors

### Connect Flexible Tubing :

- 1) Put the nut on flexible tubing (Fig. 1).
- 2) Place the insert into the flexible tubing (Fig. 2).
- 3) Push tubing with insert into the elbow to the point of resistance (Fig. 3).
- 4) Tighten the nut (Fig. 4).

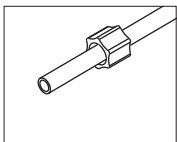

Fig. 1

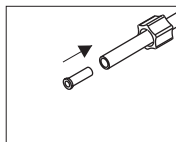

Fig. 2

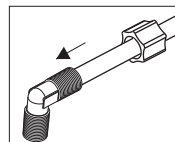

Fig. 3

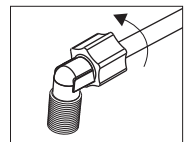
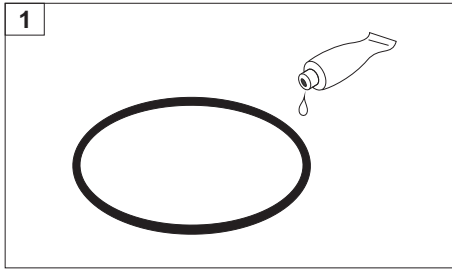

Fig. 4

## 5. Preparing systems FP3-2, FP3-K1, FP3-HJ-K1, FP2, FP3-3, FP3-4, FP3-5 for installation

Cartridge configuration for individual systems - refer to Table 1.



Before placing the O-ring inside filter head, apply white cosmetic Vaseline to it.

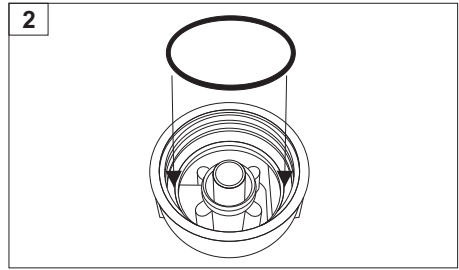

Position the O-ring into the socket of filter head. **Stretch o-ring properly and carefully arrange it in the socket head.**

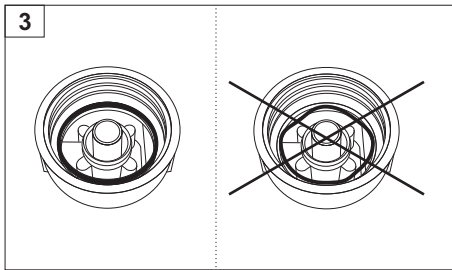

Correctly and incorrectly placed o-ring.

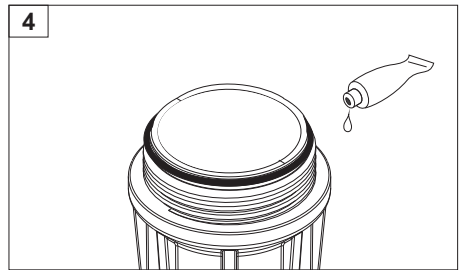

Spread white cosmetic Vaseline (not included in the set) on to O-rings (3 pieces) placed inside filter housing rims.

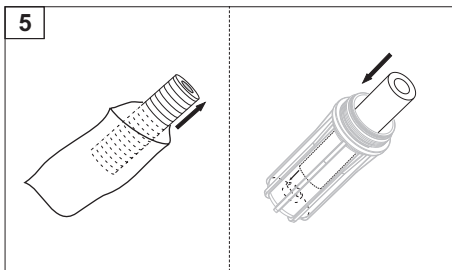

Unpack new cartridge out of plastic foil. Place filter cartridge inside filter housing sump (pressing against the top of plastic stem to ensure its central location).

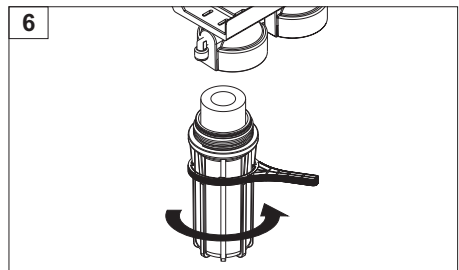

Screw in filter housing cap to filter housing sump and tighten it with wrench (remember to use the wrench perpendicularly to the filter housing). Use the same procedures for the installation of remaining filter cartridges. **ATTENTION!** If you cannot tightly screw the filter cap with filter housing sump check if all o-rings and cartridge are position correctly.

**Remember to install the cartridges in the correct order:**

- sediment (in case of sediment cartridges, first install cartridge with largest micron size, e.g. in case of FCPS20 and FCPS5 cartridges, the FCPS20 should be installed first).
- specialty (in case of specialty cartridges, install them with the gasket facing up).
- carbon (in case of carbon cartridges, install them with the gasket facing up).

**WARNING!** During cartridge installation, follow proper configuration as shown in Table 1 and pay close attention to labels with numeric values placed on the installation plates of each system.

	FP2	FP3-2	FP3-K1	FP3-3	FP3-HJ-K1	FP3-4	FP3-5
Housing 1	FCPS5-AQM	FCPS20	FCPS5	FCPS5-AQM	FCPS5	FCPS5-AQM	FCPS5-AQM
Housing 2	FCCBL-AQM	FCCBL	FCCST2	FCCST-AQM	FCCST2	FCCST-AQM	FCCST-AQM
Housing 3	-	FCPS5	FCCBKDF	FCCBL-AQM	FCCBKDF	FCCBL-AQM	FCCBL-AQM
In-line filter cartridge 1	-	-	-	-	TLCHF-2T	TLCHF-FP	TLCHF-FP
In-line filter cartridge 2	-	-	-	-	-	-	AIFIR1000

Table 1. Cartridge configuration for individual systems

## 5.1. Preparing systems for installation: systems equipped with UF membrane 2" (clear housing PET)

Prior to system installation, first install a UF membrane:

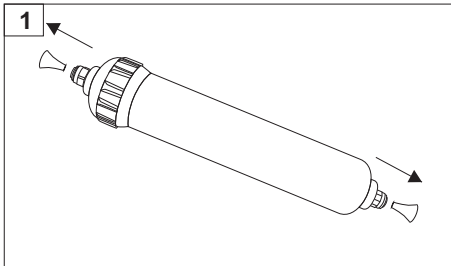

Unpack UF membrane from the foil and take out plugs from both ends.

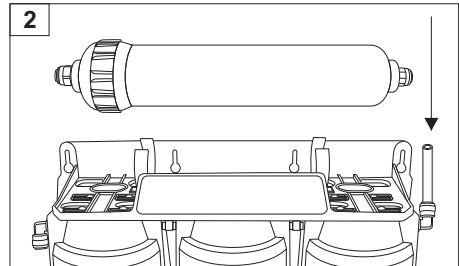

In the under counter system, install UF membrane by placing it in the brackets mounted to the installation plate. **WARNING! While installing UF membrane, remember to keep the proper direction of water flow (indicated by an arrow on membrane sticker).**

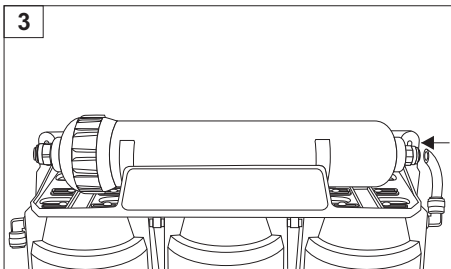

Using flexible tubing (coming out of OUT elbow), connect UF membrane with the system.

**WARNING! UF membrane is soaked with a special conserving solution.**

Install the cartridge in the direction of flow, then rinse it for several minutes before use. Use only with water microbiologically safe and adequately disinfected.

## 5.2. Preparing FP3-4 system for installation: UF membrane installation

Prior to system installation, first install a hollow fiber membrane:

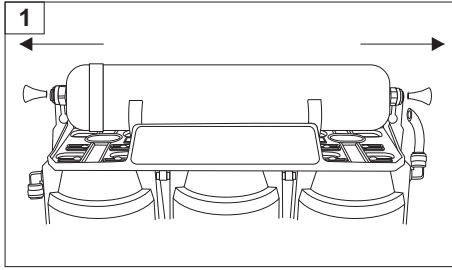

Remove plug-in from the inlet connector and UF membrane outlet.

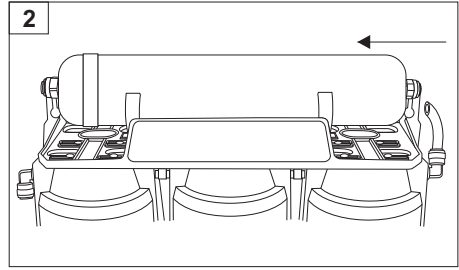

Use tubing to connect filtration system (start from elbow OUT) with UF membrane.

**WARNING! UF membrane is soaked with a special conserving solution.**

Install the cartridge in the direction of flow, then rinse it for several minutes before use. Use only with water microbiologically safe and adequately disinfected.

## 5.3. Preparing FP3-5 system for installation: UF membrane installation

Prior to system installation, first install a UF membrane:

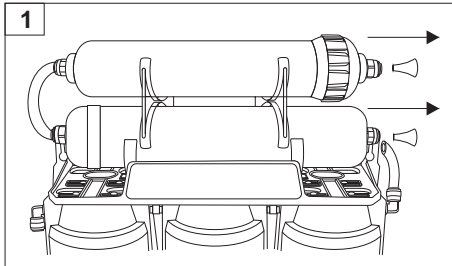

Remove plug-in from the inlet connector of UF membrane and from the inlet connector of filter cartridge **AIFIR1000**.

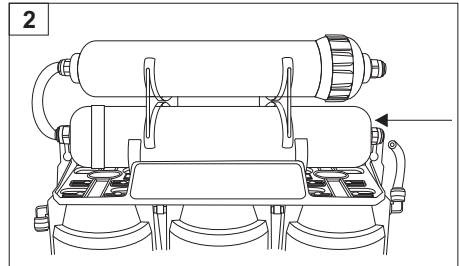

Use tubing to connect filtration system (start from elbow OUT) with UF membrane.

**WARNING! UF membrane is soaked with a special conserving solution.**

Install the cartridge in the direction of flow, then rinse it for several minutes before use. Use only with water microbiologically safe and adequately disinfected.

## 6. System Installation - Stage I

**WARNING!** Manufacturer is not responsible for any damages that result from improper installation or use of system. System installation should be performed only in temperatures above 2°C (35.6°F).

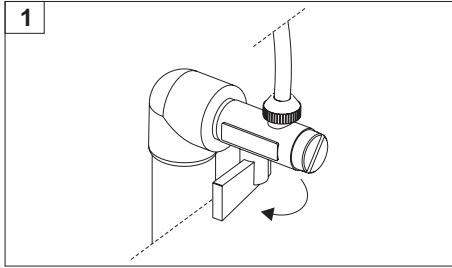

Shut off cold water supply valve.

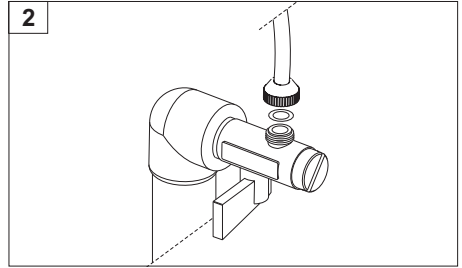

Unscrew flexible tubing from the shut-off valve (or the adapter).

**WARNING!** Between the shut-off valve and flexible tubing is a rubber gasket - be sure not to lose it.

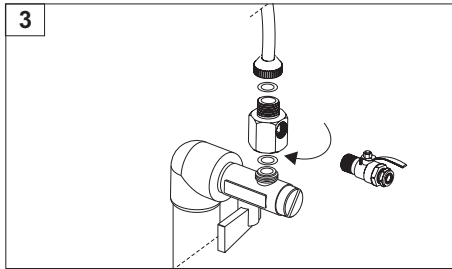

Screw chrome-plated adapter onto the shut-off valve to allow easy **SEWBV1414** valve installation and its easy opening and closing.

**WARNING!** Remember to place rubber gaskets in between the connections.

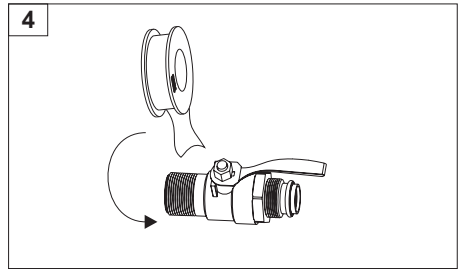

Wind a few layers of Teflon Tape **TAS0003** on shut-off valve adapter **SEWBV 1414**.

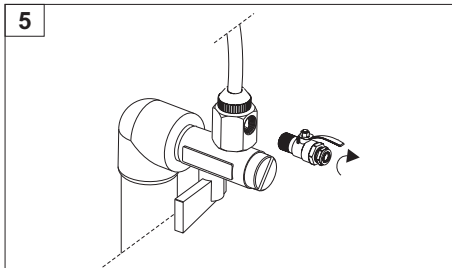

Screw **SEWBV1414** valve into chrome-plated adapter **FT06**.

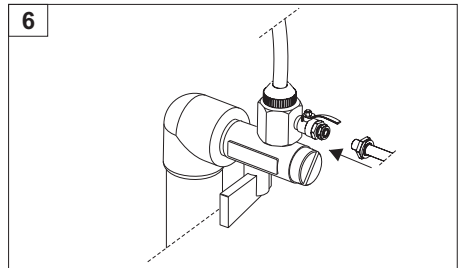

Put the nut on flexible tubing and connect it with **SEWBV1414** valve - push the tubing all the way into the valve and tighten the nut

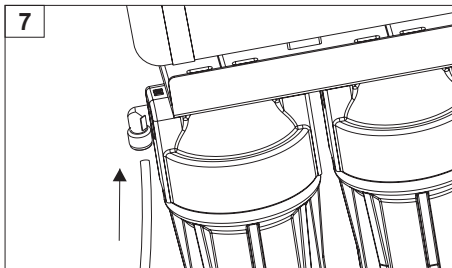

9 Connect other end of flexible tubing to the system.

**WARNING!** To seal threaded connections, always use Teflon tape during installation (does not concern threads for plastic and faucet nuts).



## 6.1. System Installation Option II - Wall Faucet

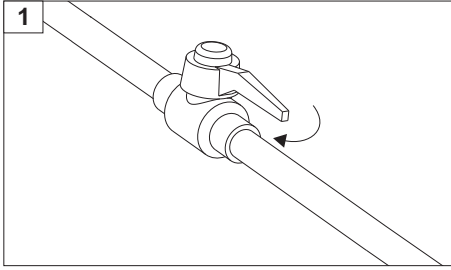

Shut off water supply valve.

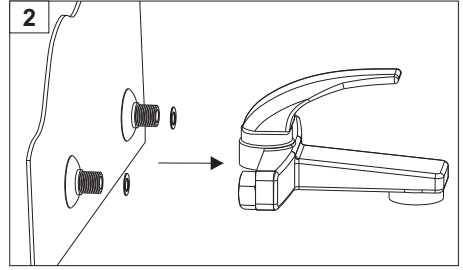

Unscrew sink faucet from the wall.

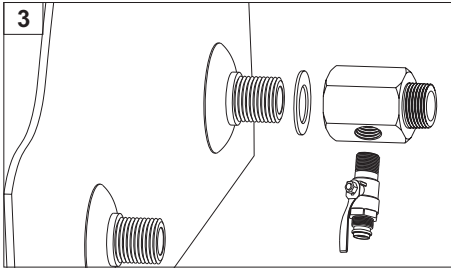

Screw chrome-plated adapter **FT07** onto cold water pipe to allow easy **SEWBV1414** valve installation and its easy opening and closing.

**WARNING!** Remember to place rubber gaskets in between the connections.

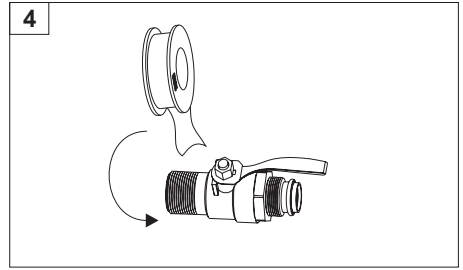

Wind a few layers of Teflon Tape **TAS0003** on shut-off valve adapter **SEWBV 1414**.

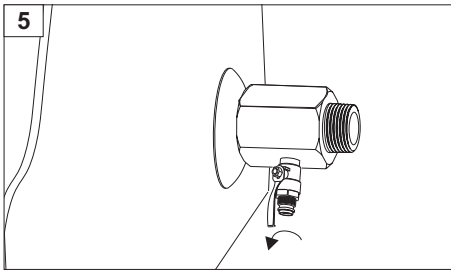

Screw **SEWBV1414** valve into chrome-plated adapter **FT07**.

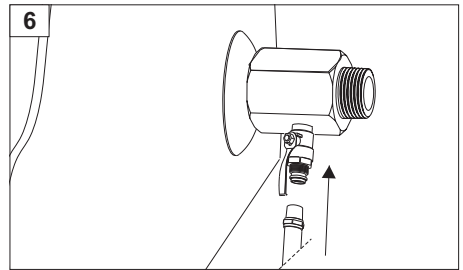

Put the nut on flexible tubing and connect it with **SEWBV1414** valve - push the flexible tubing all the way into the valve and tighten the nut.

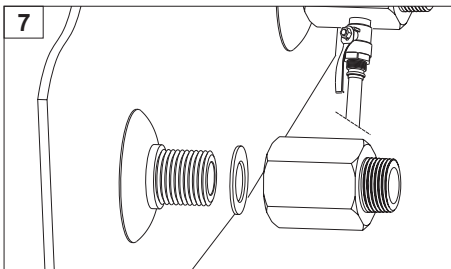

Screw chrome-plated adapter **FT07** on hot water pipe.  
**WARNING!** Remember to place rubber gaskets in between the connections.

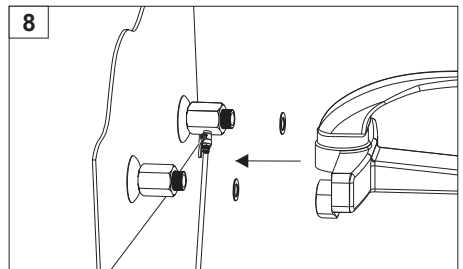

Screw sink faucet with chrome-plated adapters.

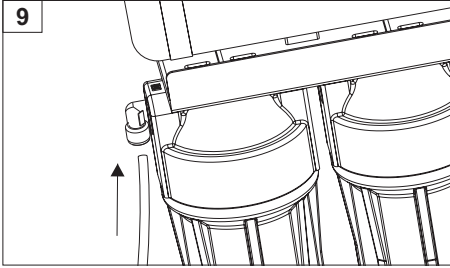

Connect other end of flexible tubing with **IN** elbow of the system.

**WARNING!** To seal threaded connections, always use Teflon tape during installation (does not concern threads for plastic and faucet nuts).

## 7. Systems Installation - Stage II - FXFCH, FXFCH5, FXFCH17-C Faucet Installation

- 1) Drill an opening 12mm in kitchen counter or kitchen sink (in case of enamel sinks the manufacturer recommends drilling openings in the structure supporting sink).
- 2) On threaded faucet extension [1], first put on cover plate [2], and then rubber gasket [3].
- 3) Secure the faucet in the drilled sink/counter opening.
- 4) Underneath the sink, put the rubber [5] and metal [6] washers on the faucet extension [4], and tighten with metal nut [7].
- 5) Install flexible tubing supplying water and connecting faucet with the system:
  - a) put the tubing [11] through the metal nut [10] and plastic tightening ring [9],
  - b) put the insert [8] into the tubing,
  - c) push flexible tubing (all the way) into the faucet extension [4] and tighten it (by hand!) with the metal nut [10].

### System FP2, FP3-2, FP3-K1, FP3-3

6) Push other end of flexible tubing with **(OUT)** elbow of the system.

### System FP3-HJ-K1, FP3-4

7) Push other end of flexible tubing 1.5 cm (0.6 in) deep into the connector of UF membrane's housing.

### System FP3-5

8) Push the other end of tubing 1.5 (0.6 in) cm into the connector which attached to filter cartridge **AIFIR1000**

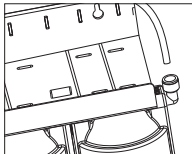

FP2, FP3-2,  
FP3-K1, FP3-3

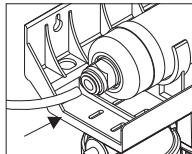

FP3-HJ-K1, FP3-4

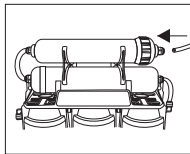

FP3-5

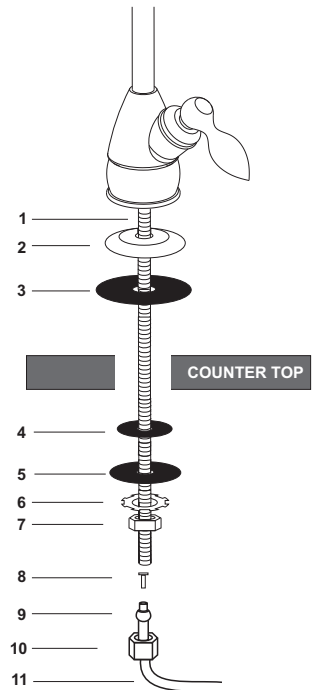







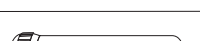
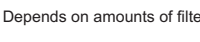

Fig. 1 Faucet Installation  
Kitchen Counter

**WARNING!** To seal threaded connections, always use Teflon tape during installation (does not concern threads for plastic and faucet nuts).

## 8. Filtration Cartridges

Cartridge Type	Description / Filtration Stage	Longevity*	Dimensions
	<b>PS20</b> Sediment, cold water cartridge for 10" housing. Designed for pre-filtration of tap and general-use water prior to the main filtration process. <b>Cartridge stops sand, rust particles, sediments and impurities carried by water</b> , and is made of polypropylene strings wound in layers. Layer density increases towards the core of cartridge assuring excellent filtration results.	3 - 6 months	9 7/8" x 2 1/2" (25,6 cm x 6,2 cm)
	<b>PS5/FCPS5-AQM</b> Sediment, cold water cartridge for 10" housing. <b>Cartridge stops sand, rust particles, sediments and impurities carried by water</b> , and is made of polypropylene strings wound in layers. Layer density increases towards the core of cartridge assuring excellent filtration results.	3 - 6 months	9 7/8" x 2 1/2" (25,6 cm x 6,2 cm)
	<b>FCCBL/FCCBL-AQM</b> Fertilizing cartridge. Contains the sintered carbon with high absorptive abilities of chlorine and organic substances contained in water. The sintered carbon has a large active surface and high efficiency of water filtration.	3 - 6 months	9 7/8" x 2 1/2" (25 cm x 6,9 cm)
	<b>FCCB</b> Water conditioner filter cartridge FCCB contains a blend of coconut shell and bituminous carbons in the ratio 75/25. It has increased water refining properties and improving the taste of water. Removes chlorine from water and organic substances causing odor and taste of water.	3 - 6 months	9 7/8" x 2 1/2" (25 cm x 7,1 cm)
	<b>FCCST2</b> two-stage, speciality type iron removing and water softening filter cartridge lowers concentration of iron, reduces water hardness by exchanging ions of calcium and magnesium into ions of sodium.	3 - 6 months	9 7/8" x 2 1/2" (25 cm x 7,1 cm)
	<b>FCCST</b> Specialty type ionizer. The filter cartridge reduces water hardness by exchanging ions of calcium and magnesium into ions of sodium.	3 - 6 months	9 7/8" x 2 1/2" (25 cm x 7,1 cm)
	<b>FCCBKDF</b> three-stage, specialty filter cartridge made of activated carbon, KDF® filtration media and polypropylene fibers. Removes mechanical impurities (sand, rust, etc.), chlorine, organic substances, pesticides, phenol, benzene, hydrogen sulfide. Lowers concentration of heavy metals such as: mercury, lead, cadmium, arsenic, etc.	6 - 12 months	10,8" x 2" (27,4 cm x 6,1 cm)
	<b>TLCHF-2T</b> UF membrane removes mechanical impurities such as rust, sand, silt, suspended solids and some bacteria and viruses. Offered in the new, transparent PET housing.	6 - 12 months	10,8" x 2" (27,5 cm x 5 cm)
	<b>TLCHF-FP</b> UF membrane removes mechanical impurities such as rust, sand, silt, suspended solids and some bacteria and viruses.	6 - 12 months	12" x 2 1/2" (30,4 cm x 6,5 cm)
	<b>AIFIR1000 2"</b> Ionizer <b>AIFIR1000</b> regulates body's pH factor and helps to detoxify body (ionized water is an excellent detoxifying agent).	3 - 6 months	10,8" x 2" (27,4 cm x 6,1 cm)

\* Depends on amounts of filtered water, its quality and level of contamination.

Before the first use of the system and after cartridge replacement, perform system flushing process. Flush the system for several minutes before use. Use only microbiologically safe and adequately disinfected water. After completion of the above operations, filtered water can be consumed.

**WARNING! All systems are compatible with the set of FP3-CRT, FP3-K1-CRT, FP3-CRT-AQM filter cartridges.**

**WARNING! Filter cartridges are not subject to complaint at the time of:**

- after opening protective packaging,
- after first use of filter cartridges.

## 9. Cartridge replacement in the following systems: FP2, FP3-2, FP3-3, FP3-K1, FP3-HJ-K1, FP3-4, FP3-5

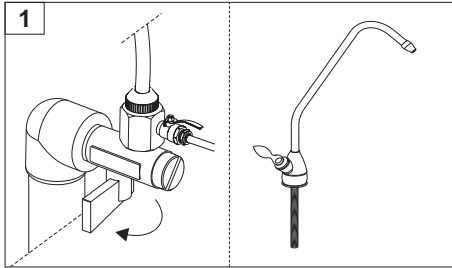

Close your water supply valve. Open faucet valve to release pressure build-up in the system.

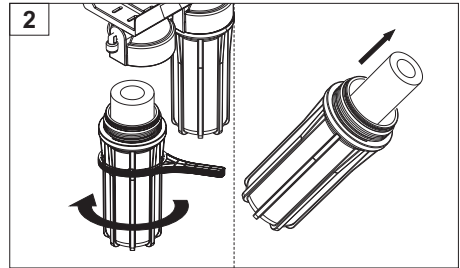

Unscrew filter housing sump from filter cap by hand or using wrench (**FXWR1-BL**). (Remember to use wrench perpendicularly to the filter housing). Remove old filter cartridge.

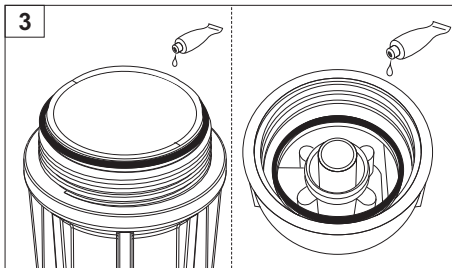

Lubricate filter housing o-rings, next turn the system 180 degree and lubricate filter cap o-rings.  
**ATTENTION! Water may leak out of filter housing 2 and 3.**  
**ATTENTION! Wash your hands thoroughly after completing the installation.**

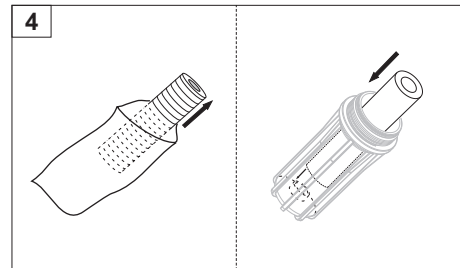

Remove filter cartridge out of plastic foil and place it inside filter housing sump (pressing against the top of plastic tang to ensure its central location).

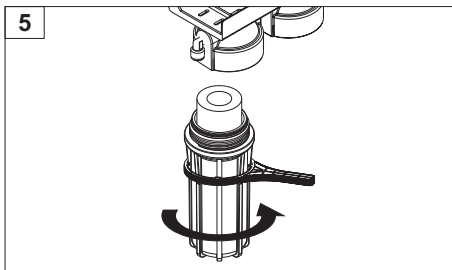

Screw filter housing sump with filter cap using wrench (remember to use the wrench perpendicularly to the filter housing). Use the same procedures for the installation of remaining filter cartridges.

**ATTENTION! If you cannot tightly screw in the filter cap with filter housing sump check if all o-rings and the cartridge are situated correctly.**

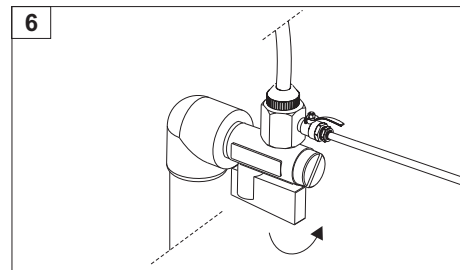

Slightly open filter faucet and next gradually open your water supply valve to fill filter housings with fresh water and release air from the system thru the faucet.

**ATTENTION! After each filter cartridge replacement procedure, all filters must be flushed out with running water for at least 5 minutes. Next do not use the system for 5 to 6 hours – during this time system seals and activates its components. Filtered water can be safely consumed after this process is completed.**

**WARNING! Before the first use of the system and after cartridge replacement, perform system flushing process. Flush the system for several minutes before use. Use only microbiologically safe and adequately disinfected water. After completion of the above operations, filtered water can be consumed..**

## 10. UF membrane replacement: FP3-4

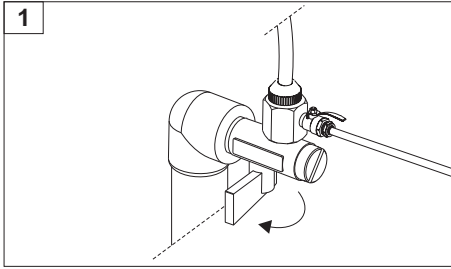

Shut off water supply valve.

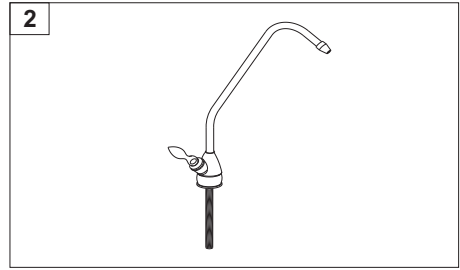

Open filter faucet to release pressure from the system.

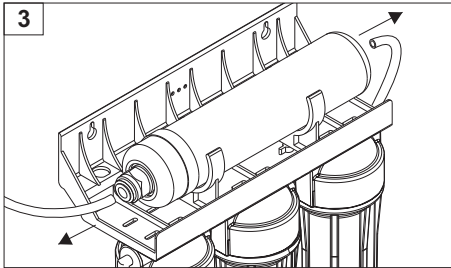

Push in the flange and pull out flexible tubing.

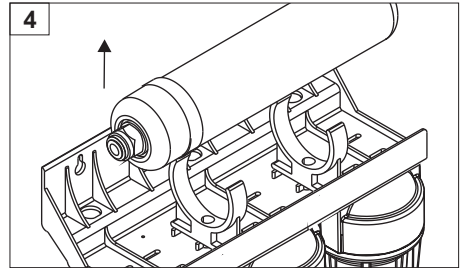

Remove UF membrane housing from mounting clips.

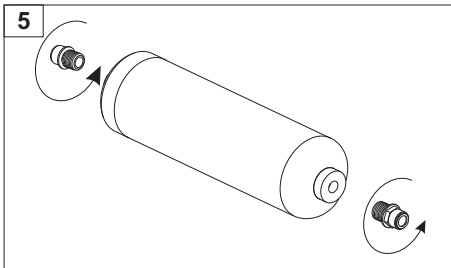

Unscrew inlet and outlet connectors from the UF membrane.

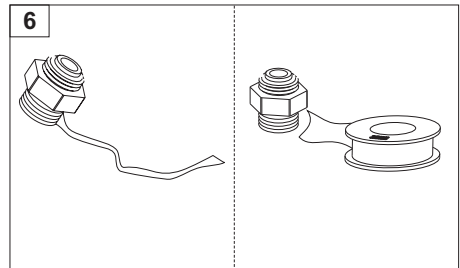

Remove all layers of old Teflon tape and apply multiple layers of new one.

**NOTE!** Ensure that Teflon tape is wound in the opposite direction to the direction connector will be installed.

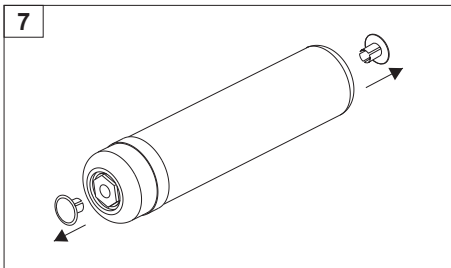

Unpack new UF membrane out of plastic foil and remove end plugs.

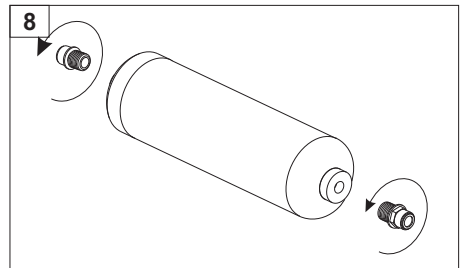

Connect inlet and outlet connectors to the housing of new UF membrane.

**NOTE!** Do NOT remove elbow connector after the installation has been started. Stopping and removing (unscrewing) the element may result in inadequate connection and water leak.

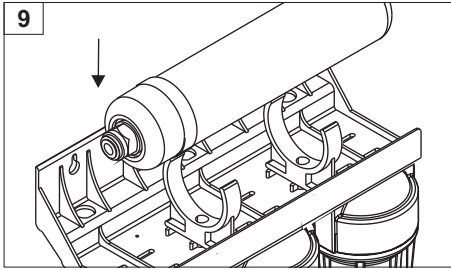

Push in membrane housing into mounting clips.  
**WARNING!** While installing UF membrane, remember to keep the proper direction of water flow (indicated by an arrow on membrane sticker).

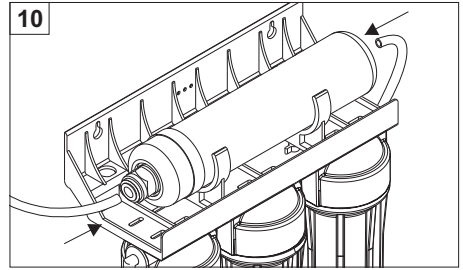

Insert flexible tubing (all the way) into both ends of UF membrane.  
**NOTE!** Check if inlet/outlet tubings are correctly and firmly connected. Make sure the tubing is not bent.

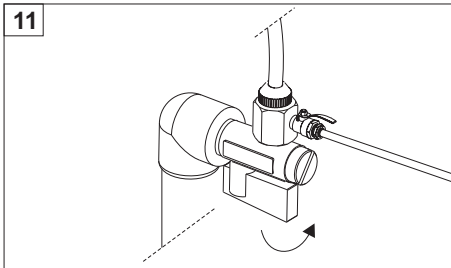

Open water supply valve.

**WARNING!** UF membrane is soaked with a special conserving solution.

Install the cartridge in the direction of flow, then rinse it for several minutes before use. Use only with water microbiologically safe and adequately disinfected.

### 10.1. UF membranes replacment: FP3-HJ-K1

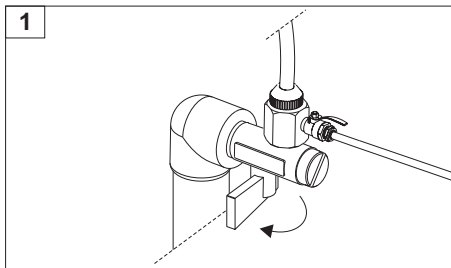

Shut off water supply valve.

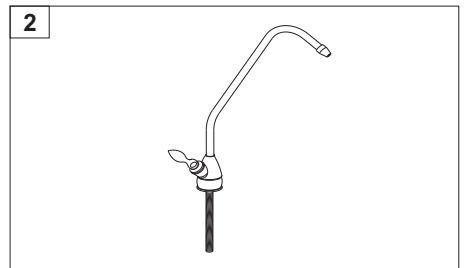

Open filter faucet to release pressure from the system.

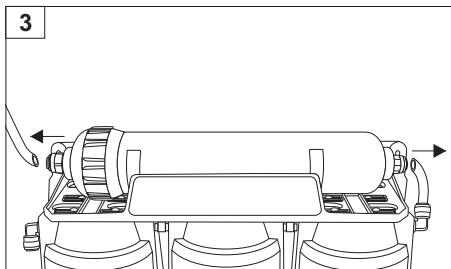

Push in the flange and pull out flexible tubing.

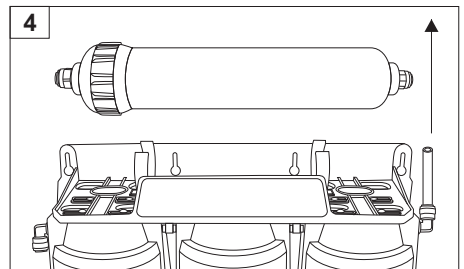

Remove UF membrane housing from mounting clips.

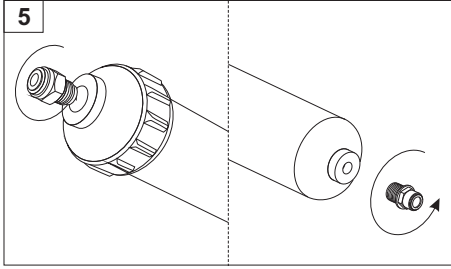

Unscrew inlet and outlet connectors from the membrane.

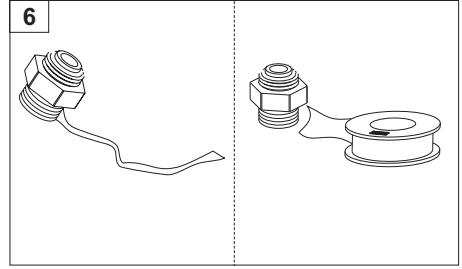

Remove all layers of old Teflon tape and apply multiply layers of new one.

**NOTE!** Ensure that Teflon tape is wound in the opposite direction to the direction connector will be installed.

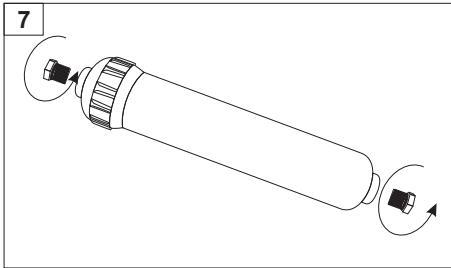

Unpack new UF membranes element and unscrew its inlet and outlet end caps.

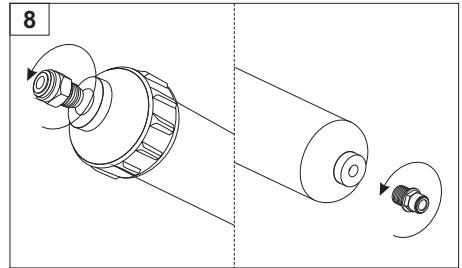

Connect inlet and outlet connectors to the housing of new UF membrane.

**NOTE!** Do NOT remove elbow connector after the installation has been started. Stopping and removing (unscrewing) the element may result in inadequate connection and water leak.

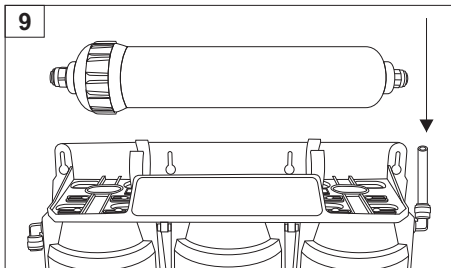

Push in UF membrane housing into mounting clips.

**WARNING!** While installing hollow fiber membrane, remember to keep the proper direction of water flow (indicated by an arrow on membrane sticker).

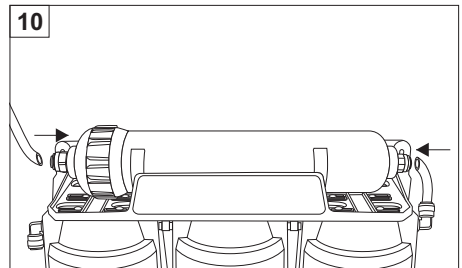

Insert flexible tubing (all the way) into both ends of UF membrane.

**NOTE!** Check if inlet/outlet tubings are correctly and firmly connected. Make sure the tubing is not bent.

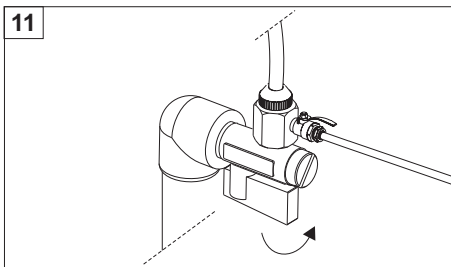

Open water supply valve.

**WARNING!** UF membrane is soaked with a special conserving solution.

Install the cartridge in the direction of flow, then rinse it for several minutes before use. Use only with water microbiologically safe and adequately disinfected.

## 10.2. Replacing UF membrane and filter cartridge AIFIR1000 in FP3-5 system

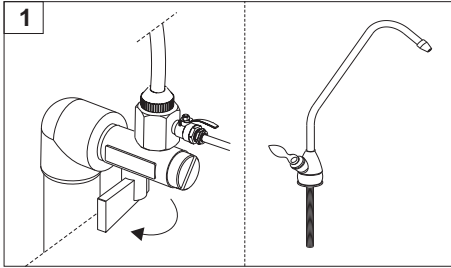

Shut off water supply valve. Open filter faucet to release pressure build-up in the filter.

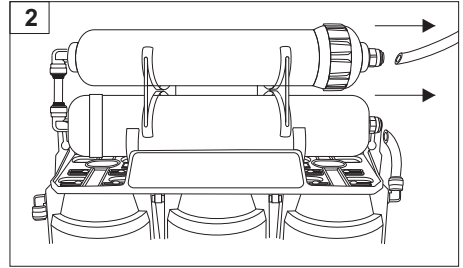

Disconnecting UF membrane and filter cartridge **AIFIR1000** from the system. First, disconnect tubing from the inlet connector attached to hollow fiber membrane. Second, disconnect tubing connecting filter cartridge **AIFIR1000** with filter faucet.

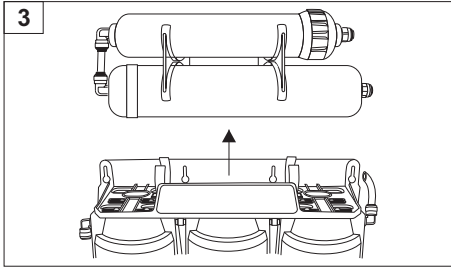

Hold filter cartridge **AIFIR1000** and UF membrane and remove them from the system.

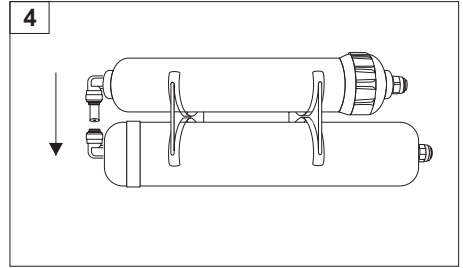

Disconnecting UF membrane and filter cartridge **AIFIR1000**. First, press outside ring of the inlet connector symmetrically and next pull out the tubing. **CAUTION! Tubing is placed inside of inlet connector which is attached to AIFIR1000. Take special care to prevent damage to the tubing.**

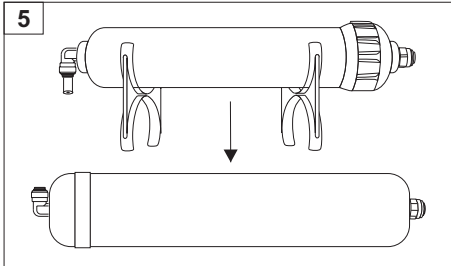

Remove UF membrane from mounting clips installed on **AIFIR1000**.

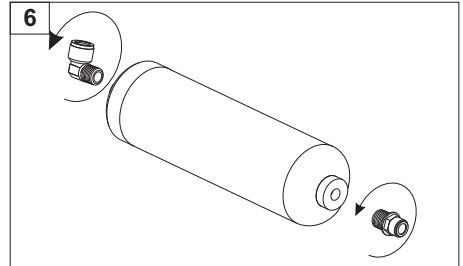

Unscrew inlet and outlet connectors attached to UF membrane housing.

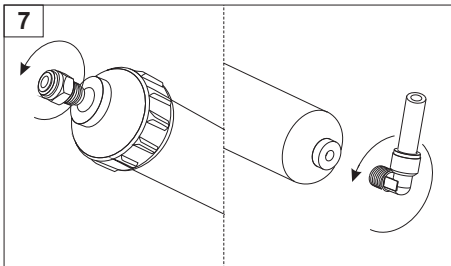

Unscrew inlet and outlet connectors from **AIFIR1000**.

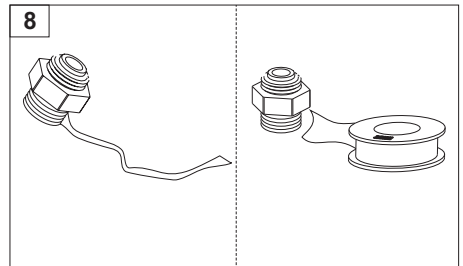

Remove old Teflon tape from the connectors. Wind several layers of new Teflon tape on each connector. **NOTE! Wind Teflon tape in counter-clock direction.**



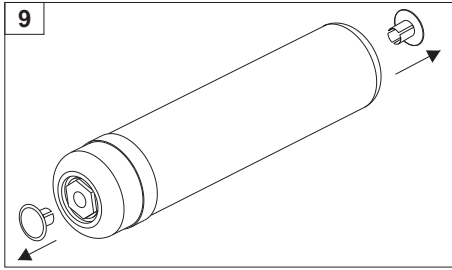

Unpack UF membrane and remove plug-ins.

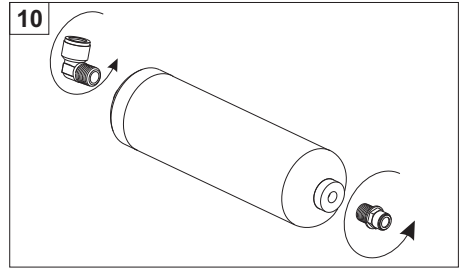

Screw-in connectors into new UF membrane housing. **CAUTION! Don't backtrack during screwing in the connectors. Backtracking connectors may result in compromising the connection seal and water leaks.**

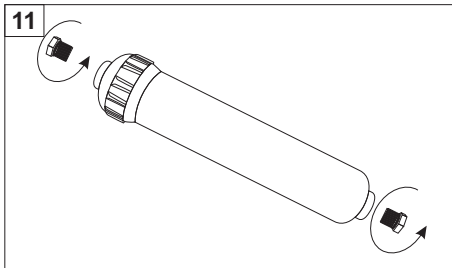

Unpack new filter cartridge **AIFIR1000** and remove plug-ins from the inlet and outlet.

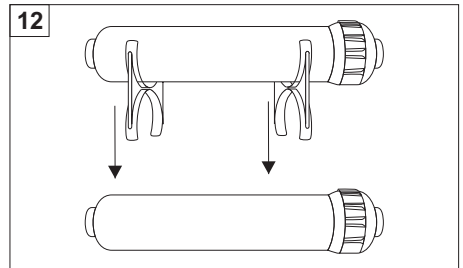

Move mounting clips from old to the new filter cartridge **AIFIR1000**.

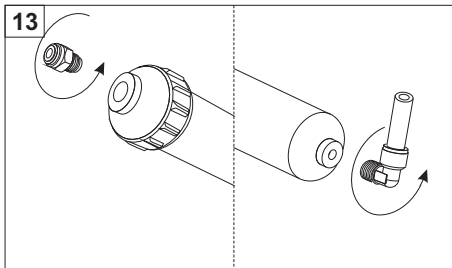

Screw in connectors into new filter **AIFIR1000** housing. **CAUTION! Connect inlet connector (with tubing) to the cartridge inlet. Next, connect outlet connector (without tubing) to the cartridge outlet. CAUTION! Don't backtrack during screwing in the connectors. Backtracking connectors may result in compromising the connection seal and water leaks.**

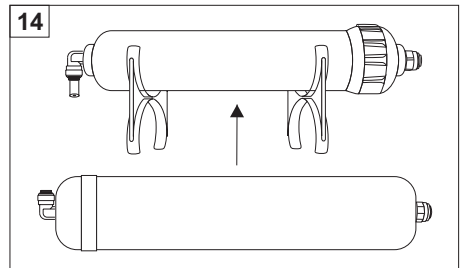

Attach hollow fiber membrane with mounting clips which are installed on **AIFIR1000** filter cartridge. **CAUTION! During the installation pay special attention to correct water flow direction. Correct water flow direction is indicated by an arrow placed on the sticker of the cartridge.**

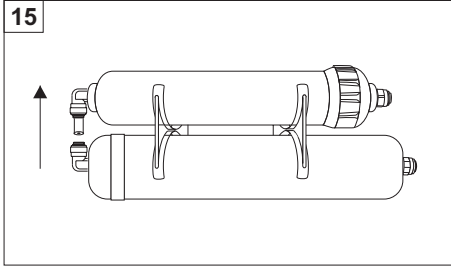

Connecting filter cartridge **AIFIR1000** and UF membrane. First, connect tubing coming out of **AIFIR1000** inlet with UF membrane outlet connector. **CAUTION! During the installation pay special attention to the tubing, prevent it from being bended or damaged.**

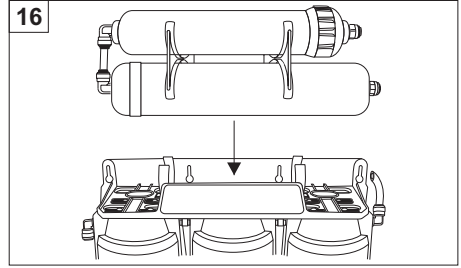

Connect filter cartridge **AIFIR1000** and UF membrane by placing UF membrane into mounting clips, which are already installed on the system mounting bracket. **CAUTION! During the installation pay special attention to correct water flow direction. Correct water flow direction is indicated by an arrow placed on the sticker of the cartridge.**

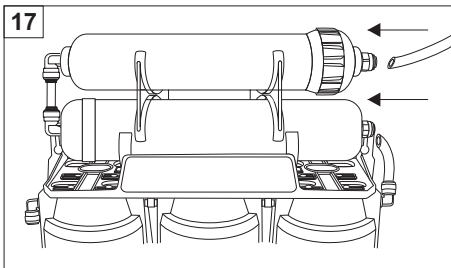

Using tubing connect elbow connector **OUT** of the filtration system with inlet connector of UF membrane. Connect filter faucet tubing with **AIFIR1000** connector. **CAUTION! During the installation pay special attention to the tubing, prevent it from being bended or damaged.**

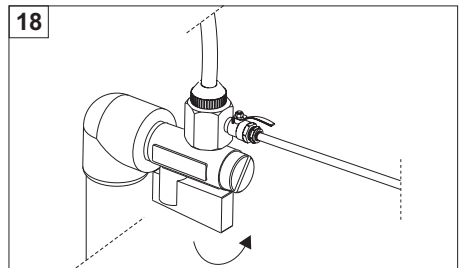

Open water supply valve.